

# SIERRASCAPE® RETAINING WALL SYSTEM

DESIGN AND INSTALLATION GUIDE



› The SierraScape® Retaining Wall System is a more affordable alternative to concrete panel or block walls for various grade change challenges.



Engineers and architects are under constant pressure to find cost-effective alternatives to traditional wall systems. For a range of applications, they are finding that the SierraScape® Wire-Formed Retaining Wall System is the ideal solution for appearance, performance, ease of installation and overall value. Backed by decades of engineering experience and with millions of square feet installed worldwide, the SierraScape System is a complete retaining wall solution, featuring materials, design, specifications and technical assistance as needed.

### THE POSITIVE CONNECTION™

The SierraScape System combines Tensar® Geogrids with a positive mechanical connection between the geogrid and the wire-form for a dependable, cost-effective solution to the most challenging grade change projects. This connection better withstands differential settlement, offers exceptional performance in areas where seismic activity or heavy external

loads are a concern and eliminates surficial stability problems often associated with other structures. It also provides a visual construction quality control check during installation.

### INSIDE AND OUT, NO OTHER WALL SYSTEM COMPARES

When it comes to structural stability, no other wire-formed retaining wall compares. The SierraScape System adapts to a variety of project conditions, design requirements and aesthetic options.

Compared to concrete panel and block walls, the system is a more cost-effective solution. Its unique wire forms ease installation and help minimize installation time and effort. The SierraScape System's low maintenance, design versatility and resistance to environmental degradation help make it the right choice for a number of retaining wall applications.

### SierraScape® System Components

Component	Function
<b>Tensar UX Geogrids</b>	HDPE structural geogrids internally reinforce fill materials. Inert to chemical degradation, they can be used with non-select fill or even recycled concrete.
<b>SierraScape Wire-Forms</b>	Galvanized wire-form baskets that provide permanent facial stability during placement and compaction of fill material, and simplify facing alignment.
<b>Locking Tail Strut</b>	Locking struts secure geogrid to the SierraScape System's basket tail and help stiffen the facing element to maintain alignment.
<b>Geotextiles</b>	Separation filter fabric provides a barrier between the backfill material and the stone fill at the face.
<b>Turf Reinforcement Mats (TRMs)</b>	Permanent erosion control products that aid in vegetation establishment and provide long-term turf reinforcement. Used only in vegetated face applications.
<b>Full Engineering and Construction Services</b>	Detailing, design, site assistance and stamped drawings for each SierraScape Wall upon request.

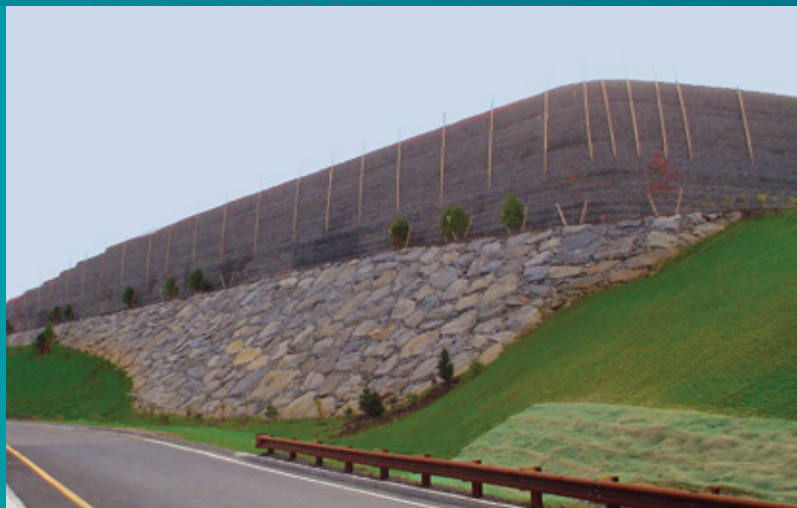

## A Complete Retaining Wall Solution

Unlike the stark appearance of most concrete wall systems, the SierraScape® System offers various facing options to meet your design needs. Options include:

- ▶ Stone – Components stack quickly and evenly to create a more uniform wall face; their flexibility and connection capabilities help resist differential settlement. Wire-form is filled with native or imported stone that can be color and size-specified for a desired look and feel.
- ▶ Vegetated – Provides a versatile soil retaining wall structure where different native vegetated covers can blend naturally with the surrounding environment.
- ▶ Architectural – Veneer treated with stacked stone or a shotcrete-sculpted face to provide a unique but traditional finish.

### EASE OF INSTALLATION KEEPS COSTS DOWN

Integrating SierraScape System components creates durable, yet simple-to-build structures.

- ▶ Small number of components, installs quickly
- ▶ No need for specialized equipment or labor
- ▶ System creates uniform wall face to easily maintain alignment
- ▶ Both fill material and disposal cost are minimized since system can use general embankment fills or on-site soils

### SierraScape System – Vegetated Face Option

### SierraScape System – Stone Face Option

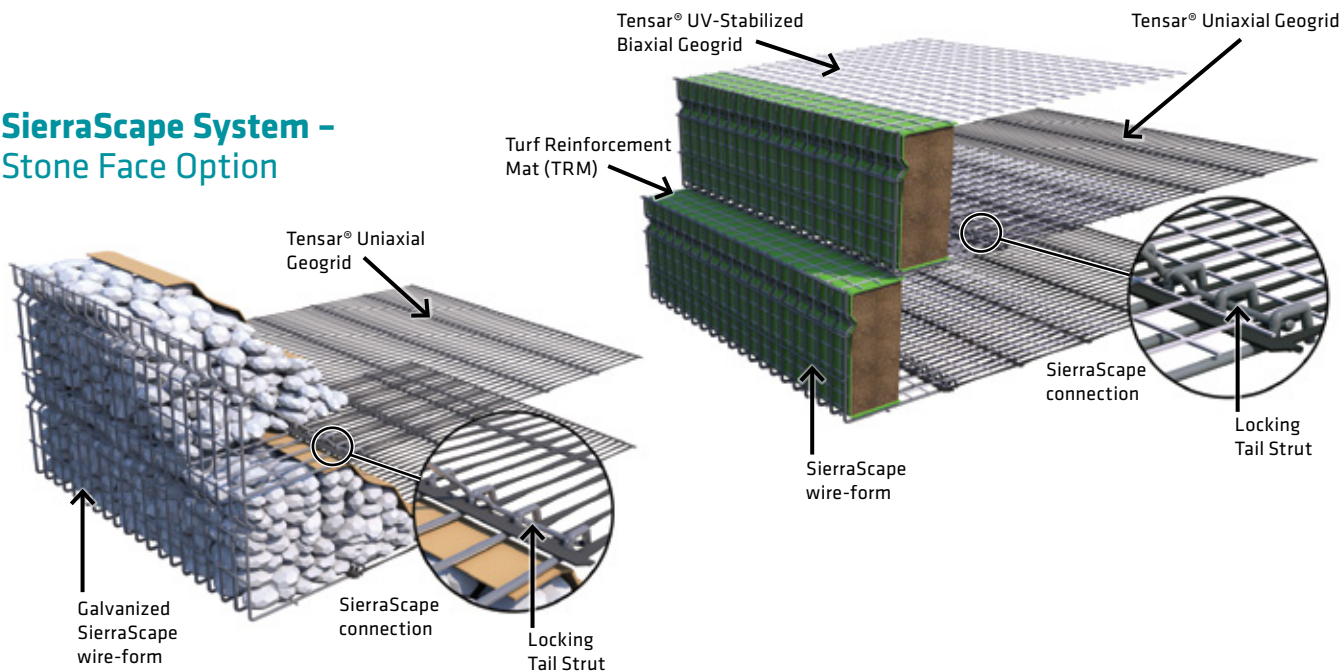



## The Positive Connection™ with an Economical Advantage

### THE SOLUTION OF CHOICE

The SierraScape® System has increasingly become the system of choice for grade separation projects in the transportation, industrial, commercial and residential markets. By combining beauty and elegance with efficiency and performance, SierraScape Walls are built to stand the test of time.

### PRESSURE RELIEF APPLICATIONS

In addition to grade separation projects, the SierraScape System can be used for pressure relief to support soil and building loads below grade, providing a faster and more affordable solution. Because the system effectively supports surrounding fill, lateral soil loads against the below-grade structure are eliminated. The result: lower cost foundation walls that are structurally equivalent to conventional installations, including cast-in-place. SierraScape Pressure Relief Walls can be specified for building foundations and existing bridges, flood walls and other new construction or rehabilitation projects.

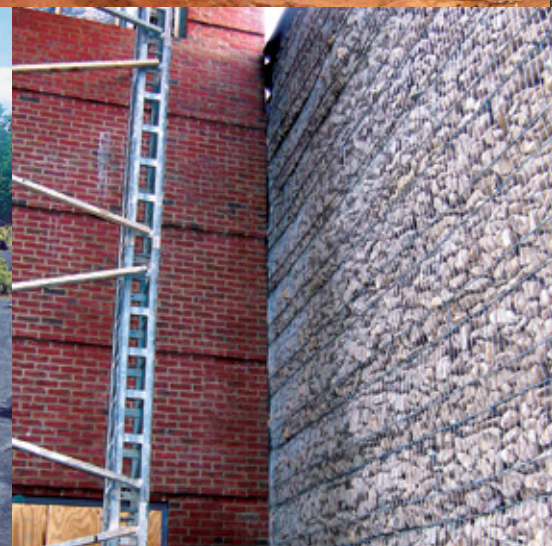

#### Post River Apartments – Atlanta, Georgia

*Environmental impact, budget and aesthetics were concerns when specifying a retaining wall for this apartment complex. The natural choice was the SierraScape System with a vegetated face.*

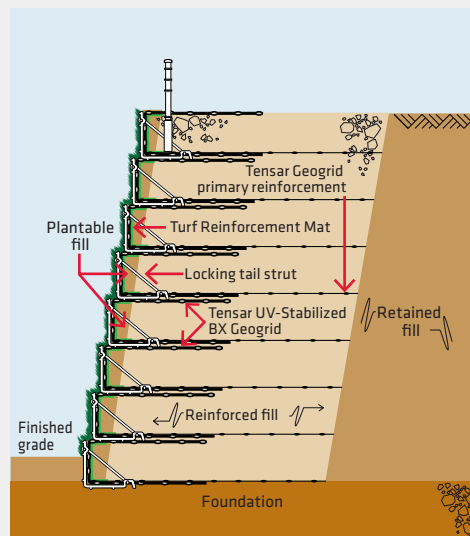

#### Brentwood Towne Square – Pittsburgh, Pennsylvania

*To eliminate lateral soil loads, a SierraScape® System Pressure Relief Wall was selected as a cost-effective alternative to traditional below-grade construction.*

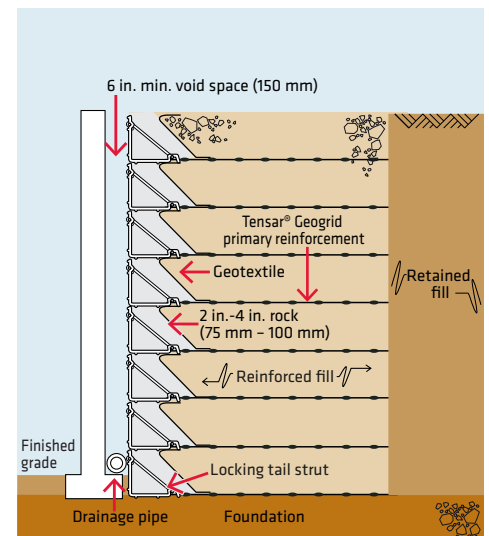



**McKelvey Woods Trail –  
Maryland Heights, MO**

*Good control of vegetated facing and proper seed selection helped establish thick vegetation less than 8 weeks after winter construction. Note that the trees don't even have leaves yet.*



**Vulcan Materials Plant – Columbia, South Carolina**

*The SierraScape System stone-filled wall and arch culvert structure allow heavy trucks easy and secure passage to and from the quarry.*



**Quail Ridge – Kelowna, British Columbia**

*The combination of stone face walls for drainage and vegetated walls for a "green" and natural look provided the ideal solution at this upscale golf community.*



**Webb Gin – Gwinnett County, Georgia**

*A two-system design combined SierraScape vegetated and stone face walls with a Mesa® Wall for a unique and aesthetic solution.*

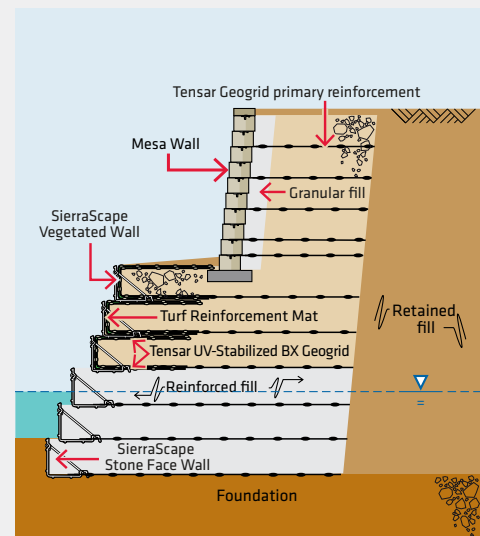
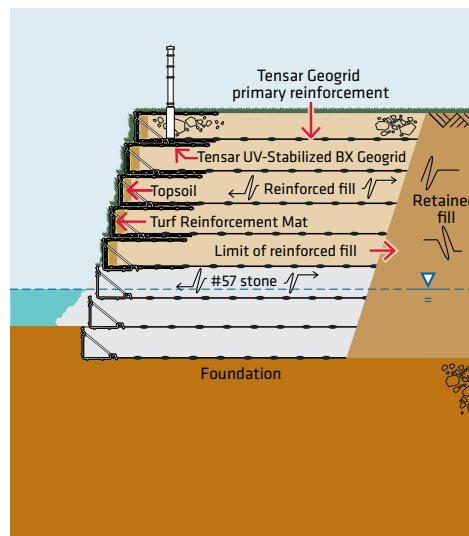
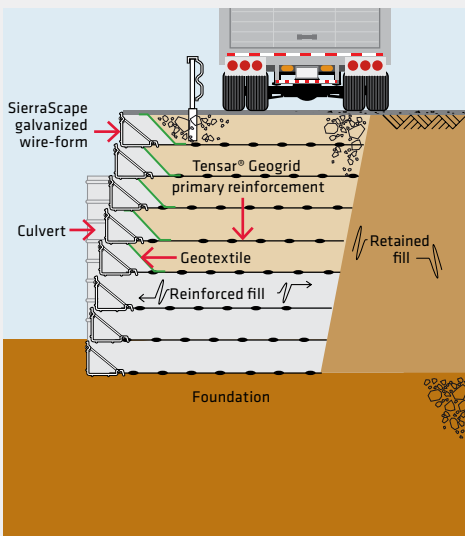

# SierraScape® Design Charts

*PLEASE NOTE: The following information is provided for general illustration purposes only and does not constitute engineering advice. Final designs should be executed only by a qualified professional engineer providing sealed drawings, calculations and detailed installation requirements. Design standards shown below may also be optimized, please contact your local Tensor representative to discuss.*

## USING THE CHARTS

The generalized design charts address four different design scenarios with wall elevations ranging from 6 ft (1.8 m) to 15 ft (4.5 m). The design scenarios alter the backfill soil type and loading conditions. Understanding these different scenarios is important for selecting the most appropriate solution for your specific design.

- ▶ **Soil Types** - The two backfill soil types are a sand material ( $32^\circ$ ) and a silty sand or clayey sand ( $28^\circ$ ) that meet a minimum gradation and plasticity recommendation provided by NCMA.
- ▶ **Loading Conditions** - The two loading conditions are:
  1. A horizontal surface at the top of the wall with a uniform surcharge of 250 psf
  2. A 3H:1V slope on top of the wall

Once the most appropriate design has been selected, the charts will provide the suggested geogrid type, embedment length and geogrid spacing. All lengths listed are measured from the wall face to the last transverse bar\* on the Tensor Geogrid and are uniform throughout the given elevation of the wall.

The design charts assume that the walls are constructed in accordance with the SierraScape Systems standard specification and installation guidelines. Other requirements and limitations based on the actual site conditions may also apply.

*\*The transverse bar is the solid section of the Tensor UX Geogrid, approximately 3/4 in. wide, located parallel to the face of the retaining wall and in a repeat pattern at a 6 in. to 20 in. spacing (depending upon the type of UX Geogrid).*

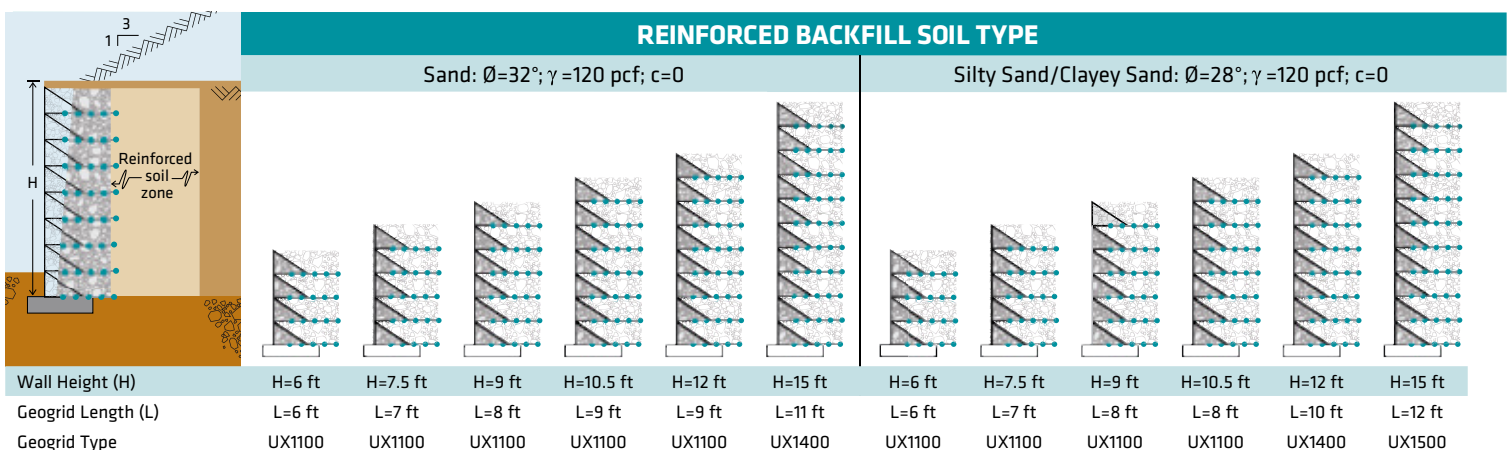
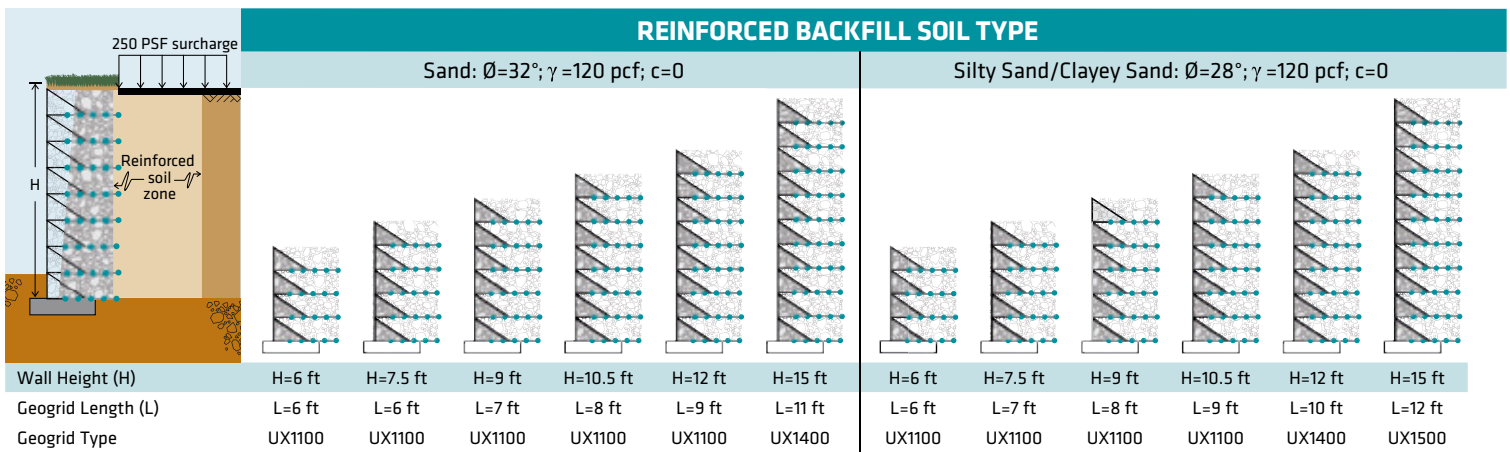

For further information, please refer to the TensorSoil-PRO™ Software.

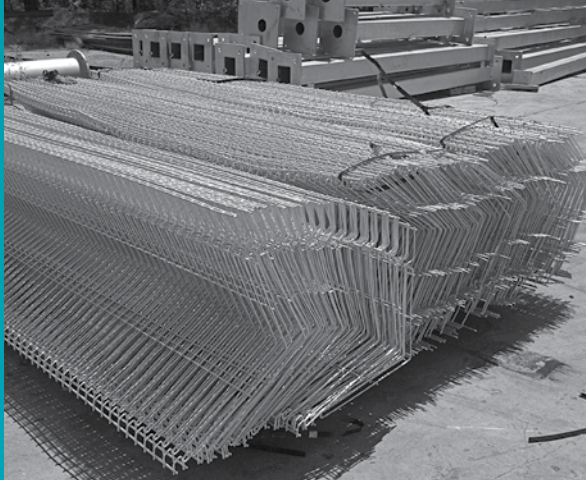

The geogrid should be color-coded by type prior to removing the labels.



# 1. Materials & Handling

## MATERIALS SUPPLIED BY TENSAR

- ▶ Tensar® Uniaxial (UX) and UV-Stabilized Biaxial (BX) Geogrids
- ▶ SierraScape® Wire-Forms
- ▶ Locking Tail Struts
- ▶ Non-woven needle punched geotextile, or Turf Reinforcement Mat (TRM) from Tensar® North American Green® (depending on facing option)

## HANDLING WALL MATERIALS

- ▶ Tensar® Geogrids are shipped in rolls. The Contractor is responsible for unloading the rolls. Prior to the removal of the roll labels, the Contractor should color-code each of the geogrid types using spray paint on the edges and ends of the rolls. For physical dimensions of SierraScape geosynthetic materials, see chart on page 4.
- ▶ SierraScape® Wire-Forms are delivered in bundles while the Locking Tail Struts come in clear bags. Geotextile and TRM products are shipped in rolls. All materials are to be unloaded by the Contractor.
- ▶ It is the Contractor's responsibility to verify the quantities shipped and the condition of the materials when delivered.
- ▶ If certifications are required by the contract documents, and requested by the Contractor, they will be supplied. It is the Contractor's responsibility to ensure that the Engineer receives this information.

### SierraScape System - Stone Face Option

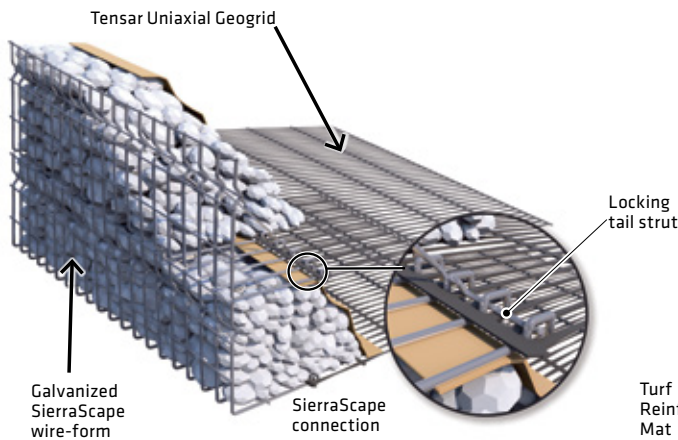

### SierraScape System - Vegetated Face Option

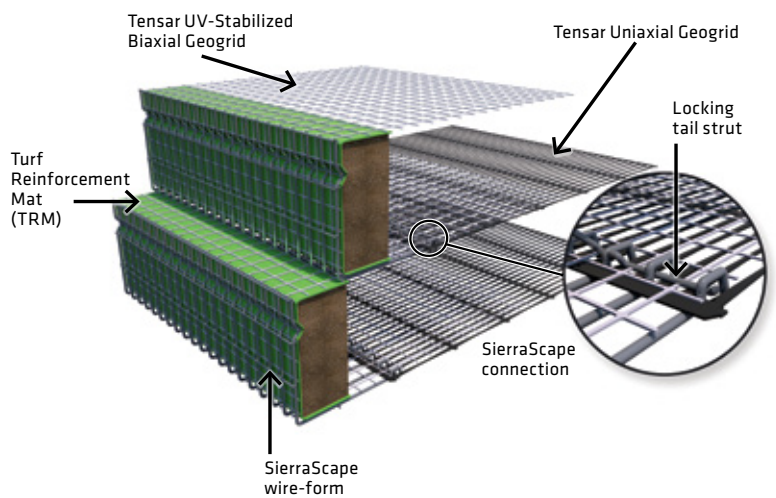



A



B

**A)** The Contractor is responsible for supplying alignment tools such as a stringline.

**B)** Adequate labor, equipment and supervision is necessary to complete the wall installation.

### CONTRACTOR SUPPLIED MATERIALS

- ▶ Select or plantable fill for the face of the SierraScape structure and all other fill to be placed in the reinforced zone
- ▶ Cable ties, tie wire or hog rings
- ▶ Utility saw for field cutting of geogrid and wire-forms
- ▶ Alignment system tools (laser, stringline, 4 ft level, etc.)
- ▶ Side cut shears to cut the geogrid at the facing of the wire-forms
- ▶ All labor, equipment and supervision necessary to perform the total wall construction (installation crew)

## 2. Responsibilities for Construction Compliance

- ▶ The Contractor must construct the wall in accordance with the contract documents, plans and specifications. The Contractor is also responsible for the verification of line, grade and other physical features of the SierraScape structure.
- ▶ The Contractor may request the assistance of the Tensar Project Manager to assist with the procedures within this guide and the contract plans, documents and specifications. The Tensar Project Manager may be onsite at the start of construction and thereafter only as requested or necessary.
- ▶ The Contractor understands that Tensar Project Manager is not authorized to revise any details or instructions in these guidelines, or on the approved contract documents, plans or specifications, without the express written agreement of the Engineer.

### Geosynthetic Materials Schedule

TYPE	SIZE	WEIGHT
<b>UX-MSE Geogrid</b>	4.36 ft wide x 200 or 250 ft long	70 - 150 lbs
<b>UV-Stabilized BX Geogrid</b>	9.8 or 13 ft wide x 164 or 246 ft long	67 - 140 lbs
<b>Geotextile (stone face only)</b>	3.75 ft wide x 360 ft long	37 lbs
<b>TRM (vegetated face only)</b>	6.5 ft x 55.5 ft/6.7 ft x 108 ft	37 - 45 lbs





Often, the geogrid cutting process is staged in an area away from active construction activity.

Tensar UX Geogrid Cut Details

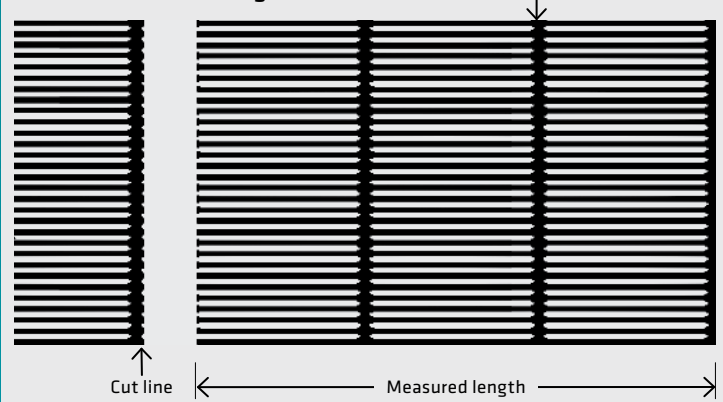

### 3. Site Preparation

- ▶ Verify the condition, approval and receipt of the SierraScape® System's Wire-Forms, Locking Tail Struts, Tensar® Geogrid, geotextile, TRM (if required) and fill materials. Materials should arrive in good condition. Tensar will replace materials that have not been accepted by the Contractor. Please call Tensar immediately upon receipt of any damaged SierraScape components.
- ▶ Grade and proof roll subgrade as outlined in contract documents, plans and specifications.
- ▶ The subgrade should be approved by the owner's Engineer before proceeding with the wall construction. Any soils found unsuitable by the Engineer should be treated in a manner approved by the Engineer.
- ▶ Install offset stringline, story pole or other control to check and maintain wall alignment and grade.
- ▶ Color-code and pre-cut the geogrids, geotextiles and TRMs (if applicable) to the lengths outlined on the plans. A utility saw can be used to cut the geogrid. Make the geogrid cuts next to the heavy transverse bars that span the width of the rolls. As geogrids are cut, mark and tag them according to the length and type. All geosynthetics can then be stockpiled for use as needed.

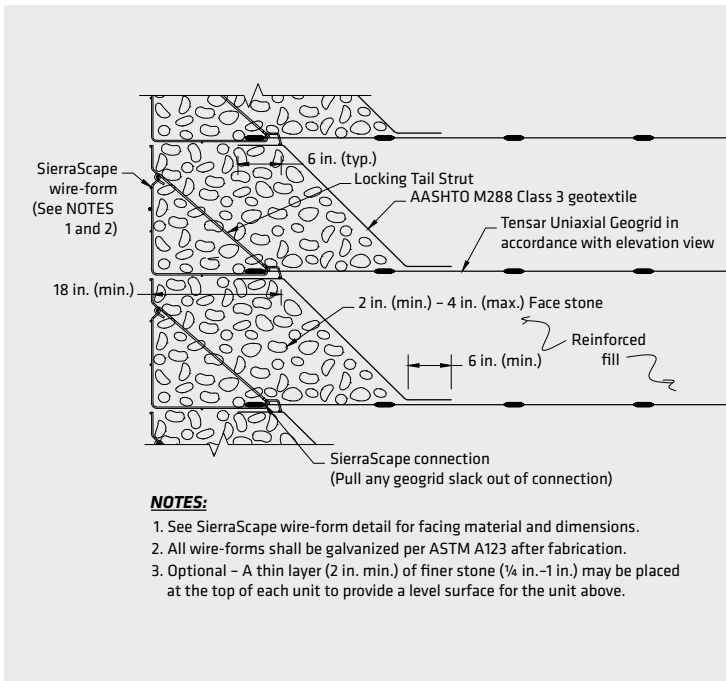

Typical stone-face SierraScape detail

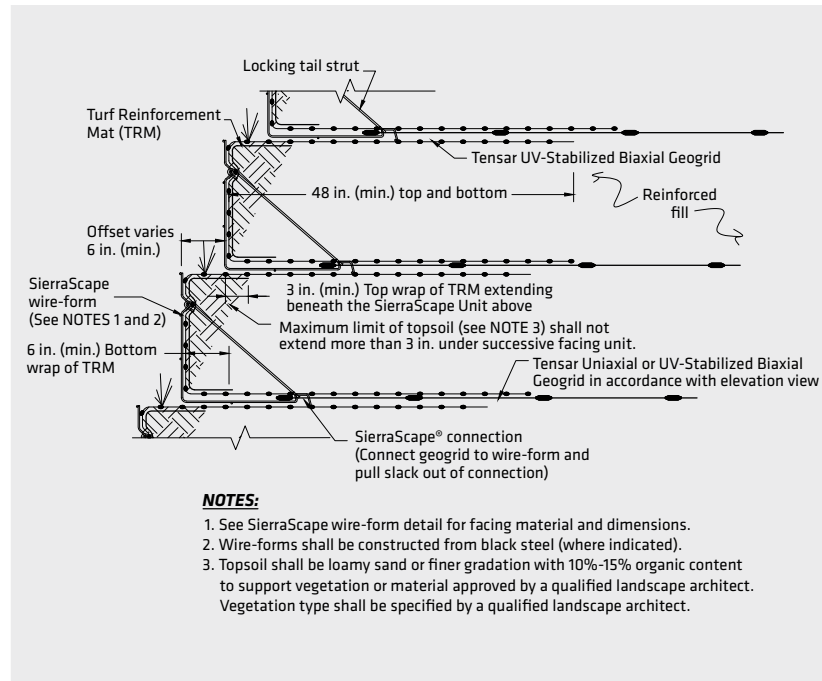

Typical vegetated-face SierraScape detail

Insert the tail of the strut through the connection loops (1) from the back and rotate upward (2) to fasten to horizontal wire at the corrugation.

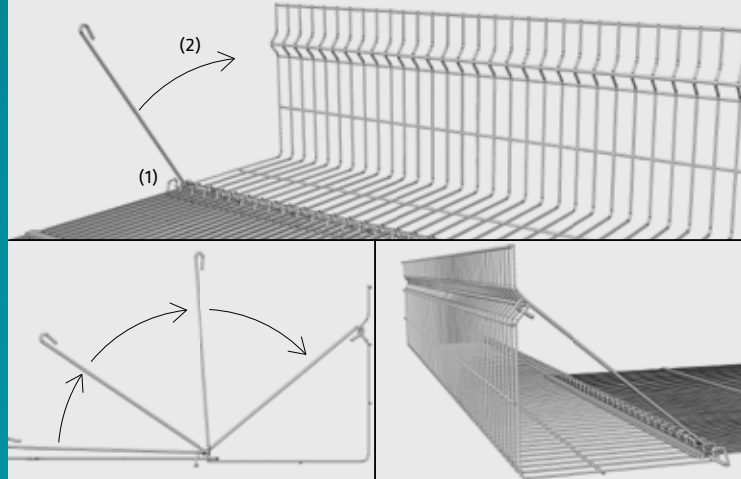

## 4. Installation

- ▶ Install the wire-forms on level grade. Butt vertical members of adjacent forms end-to-end with the extended horizontal wires on one unit overlapping the adjacent unit by 2 in.

**NOTE:** The wire-forms may move forward during placement and compaction of the backfill. Set the first few courses of the wire-forms 1 to 2 in. behind the wall face control line. Adjust the setback of upper courses based on observed movements.

- ▶ Attach the end of the vertical wires of the adjacent units with cable ties, hog rings or tie wires to aid in maintaining alignment.
- ▶ Two full width panels of UX Geogrid should be attached to each wire-form. The UX geogrid panels should not overlap adjacent forms, or one another. The outer two ribs of each geogrid panel should be placed between the outer two wires of the wire-forms. Two geogrid ribs should be positioned between each pair of wires. The transverse bar of the UX Geogrid will have to be cut in places to position pairs of ribs between pairs of wires as seen in the photo below. Cuts should be made only at apertures between wire pairs.

**NOTE:** The transverse bar may need to be cut at additional locations to allow contact between the geogrid and the connection loops. A maximum of five cuts is allowed per geogrid roll width.

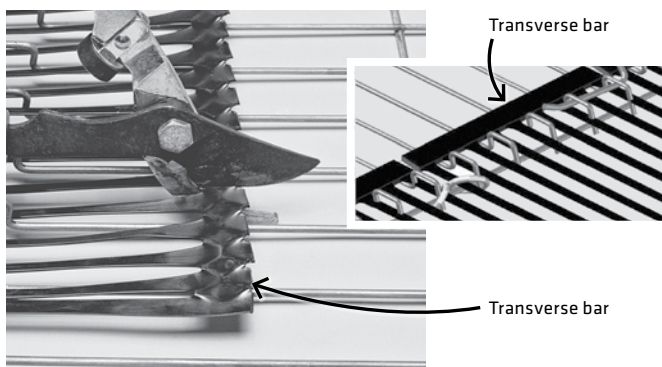

When geogrid apertures do not perfectly align with the SierraScape Wire-Form's "loops," cut the geogrid at the transverse bar that does not bear on a connection loop.

- ▶ Fasten geogrid to bottom wire with hog rings, cable ties or tie wire in areas where the geogrid is cut.
- ▶ Place the TRM and/or UV-Stabilized BX Geogrid as specified where face fill is finer than 2 in. Where 1 to 2 in. stone-face fill is specified, use UV-Stabilized Biaxial Geogrids to retain the stone. If a vegetated face is specified, use a permanent Turf Reinforcement Mat (TRM) from Tensar North American Green, such as C350 or SC150. The face backing should be wide enough to cover the face and extend 6 in. under the fill. (See typical vegetated face SierraScape detail on pg 5.)
- ▶ Adjacent rolls of UV-Stabilized BX and/or TRM shall be overlapped 6 in.
- ▶ Insert the tail of the strut through the connection loops from the back on top of the geogrid and rotate upward to fasten to the corrugation towards the top of the basket.
- ▶ Struts should be placed approximately 16 in. apart.
- ▶ One strut should be positioned between the two end wires to support the joint between adjacent wire-forms.

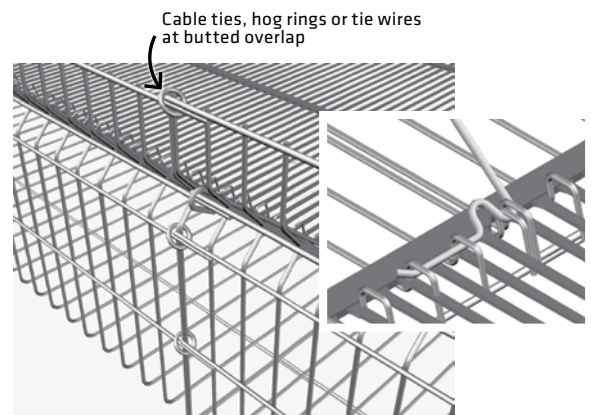

Install Locking Tail Struts across the butted ends of the SierraScape Wire-Form.



A



B

**A)** Install backfill over the geogrid panels.

**B)** Place stone fill within the wire-forms.

## Installation continued...

- ▶ In preparation for fill placement, pull the UX Geogrid toward the reinforced backfill zone (away from the facing unit) so that it's tight against the connection. Maintain facing alignment during this process. Place the first 9 in. backfill lift on top of the geogrid (maintain an open zone at the wire-form for the stone fill). The backfill should be placed and advanced from front to rear of the reinforced fill zone, so that any loops or wrinkles in the geogrid are worked out towards the free end of the geogrid. (See left-hand photo above.)
- ▶ After the backfill is placed, position the pre-cut geotextile roll along the backfill's front edge (if required). A tab of at least 6 in. of geotextile is required to extend beyond the stone facing.
- ▶ Install facing fill materials in 9 in. lifts unless the plans require otherwise.
- ▶ Compact facing and reinforced fill materials within 3 ft of the wall face or as required in the plans. A vibratory plate tamper is recommended for compaction in this area (3 ft away from wall face).

**NOTE:** Proper compaction at the wire-form will minimize "pillowing" of the lower wire-forms as wall construction proceeds. Conventional compaction equipment may be used to compact reinforced fill beyond the 3 ft face zone to 95% of AASHTO-T99 maximum dry density or as otherwise specified. Each compacted lift should be no more than 9 in. thick.

- ▶ Alignment adjustments will be required as the type of fill, moisture content, equipment and wall height will affect the amount of movement of an individual wire-form.

**NOTE:** Wire-forms may not move uniformly. Subsequent rows of units can be set with a relative setback based upon observed movements. The Contractor should check facing alignment as

each course is placed.

*\*The process shall be repeated for each subsequent lift of baskets and soil.*

The following tolerances will need to be checked as the SierraScape System is being constructed:

- ▶ Vertical and horizontal alignment of the wall face shall not vary by more than 2 in. per 10 ft, or as shown in the plans and specifications.
- ▶ The overall vertical tolerance (plumbness) of the SierraScape structure shall not exceed 1 in. per 10 ft of wall height. Negative (outward leaning) batter is not acceptable.
- ▶ The offset limit between consecutive courses of wire-forms shall not exceed 1 in. from the planned offset.
- ▶ At the end of each day, the Contractor must ensure that the reinforced backfill is graded to drain water away from the face of the wall. Berms and/or ditches must also be in place and functioning to prevent the intrusion of runoff water into the wall construction area.

### The SierraScape® System Advantage

For more than 30 years industry professionals have been using Tensar® Geogrids to build economical, long-lasting structures. With clear advantages in performance, design and installation, the SierraScape System offers a proven technology for addressing the most challenging site conditions.

For more information on our full line of Grade Separation Solutions, call **800-TENSAR-1**, visit **www.tensarcorp.com** or send an e-mail to **info@tensarcorp.com**. We are happy to supply you with additional information, system specifications, design details, conceptual designs, preliminary cost estimates, and much more.

# Tensar®

Tensar International Corporation  
2500 Northwinds Parkway, Suite 500  
Alpharetta, Georgia 30009

**TensarCorp.com**  
800-TENSAR-1

*Distributed by:*

